

Stabilization of Quasi-Passive Pneumatic Muscle Walker

Takashi TAKUMA¹, Koh HOSODA^{1,2}, Masaki OGINO¹ and Minoru ASADA^{1,2}

¹*Dept. of Adaptive Machine Systems,*

²*HANDAI Frontier Research Center,*

Graduate School of Engineering, Osaka University,

Yamadaoka 2-1, Suita, Osaka 565-0871, Japan,

{takuma, ogino}@er.ams.eng.osaka-u.ac.jp,

{asada, hosoda}@ams.eng.osaka-u.ac.jp

A passive Dynamic Walker can walk down an inclined floor without any actuators. When the passive dynamic walking is modified to use actuators, it is called “Quasi-passive walking”. This locomotion is efficient in energy consumption. An antagonistic paired pneumatic actuators is suitable for quasi-passive walking because the joint with the actuators can easily switch to be active / passive. However, it is more difficult to control a robot with pneumatic actuators than one with electric actuators because the pneumatic actuator has complex nonlinearity. One of the approaches to realize stable walking of the walker with pneumatic actuators is observing a causal relation between walking parameters and sensory data by using real robot. In this paper, we design a controller to stabilize walking cycle from the observed relation. We also check the performance of the control by letting the robot descend a small difference in level.

Keywords: pneumatic muscle actuator, biped robot, stabilization of walking, quasi-passive dynamic walking, controller design

1. Introduction

A passive dynamic walker can walk down an inclined floor without any actuators. Advantages of the passive walking are, compared with usual locomotion with electric motors, that it does not consume explicit energy and that walking trajectory planning and motor control are not needed.

Quasi-passive dynamic walking means that robot walks with actuators based on the passive walking even if the floor is not inclined. It is expected to be efficient in energy consumption. One of the issues on quasi-passive walking is an adoption of suitable actuator. Asano et al. equipped the electric motors on a passive walker to generate virtual gravity effect³ and to control mechanical energy⁴. Though usual electric motor can generate desired torque precisely, it is difficult to switch the joint to be active / passive. Sugimoto et al. proposed a control law for quasi-passive walker in order to realize stable passive walk. They use direct-drive motors which can switch the joint active or passive, and the motors inlet torque that keeps the robot walking with constant kinetic energy upon heel strike². The size and weight of the whole system for the direct-drive motor are, however, too big to build in a self-contained robot.

The pneumatic actuators in an antagonistic pair is suitable for quasi-passive walking because the joint with the actuators can easily switch the joint active or passive, and the system to operate the actuators is appropriate for a self-contained robot. Wisse et al. built a biped robot with the muscle actuators to walk on a flat floor¹. Though they realized walk by adjusting periods to open air valves to supply air into the actuators that let the robot walk, the robot can not adjust to terrain changes because the durations of opening valves are fixed. To our knowledge, there is no research to control biped robot with pneumatic actuators for stable walking cycle.

One of the approaches to stabilize walking cycle is that robot's model is derived numerically and controller is designed analytically. In these twenty years, several articles have been devoted to deriving dynamic equations of motion of robot arms, not biped robot, with pneumatic actuators and designing optimal position controllers based on these equations^{8,9}. However, the performance of the controller is not enough because the nonlinearity of actuators is too complicated to be modeled as equations.

An another approach is that real robot is built and a causal relation between walking parameters and sensory data, walking cycle, is observed by using the robot. If the relation is observed, we can design a feed-back controller even though we can not obtain the dynamic model of the robot.

We apply the latter approach to design the controller. In this paper, we build real biped walker with McKibben muscle actuator, which is a kind of pneumatic actuator, and we observe the causal relation between walking parameter and walking cycle to design feed-back controller. We also confirm the effect of the controller by letting the robot descend small differences in level.

In section 2, the developed biped walker with McKibben muscles is introduced. In section 3, walking strategy and the control law are explained. In section 4, the experiments and results are shown.

2. Development of biped walker with McKibben artificial muscles

In this study a McKibben artificial muscle, which is a kind of pneumatic actuator shown in fig. 1, is used to actuate a quasi-passive walker. The McKibben muscle contains two principle components. It has an inner inflatable bladder made of silicon and an exterior braided shell made of nylon. The muscle expands radially and contracts axially when the air is supplied into the inner tube shown in fig. 1 upper, and it generates pulling force along the longitudinal axis. The actuator is extended when the air is exhausted from it shown in fig. 1 bottom. The actuator is suitable for humanoid running and hopping because of its low weight, spring characteristic and efficiency, but complex nonlinearity of the actuator such as hysteresis and friction between the exterior net and inner tube prevents precise control. Although actuator models have been proposed in some researches^{5,6,7}, they do not express the characteristics of the actuator precisely.

We use the McKibben muscles made by HITACHI Medical Corporation¹⁰. It is about 200[mm] in length and 20[mm] in radius when it contracts, and it generates a force of about 800[N] when the pressure in the inner tube is about 0.7[MPa]. A brief illustration of the robot is shown in fig. 2. It has three joints : two knees and one hip. Each joint is rotated by two actuators that are arranged in an antagonistic pair like animal muscles.



Fig. 1. A McKibben type actuator. When the air is supplied into inner tube, it is shrunk (upper), and extend when the air is exhausted (bottom).

Fig. 3 shows an overview of a system to rotate one joint. The air supply and exhaust valves are attached to the actuator, and the actuator is contracted when the supply valve is open and it is extended when exhaust valve is opened. The PC operates air valves via D/A converters and amplifiers, and it reads sensory information such as touch sensor data on the foots of the robot via A/D converters. In fig. 3, the joint is rotated counter clock wise when actuator 1 is contracted while actuator 2 is extended, and vice versa.

Fig. 4 shows a basic structure of the robot with pneumatic actuators. The frame is made of aluminum and the six actuators are arranged to rotate joints. The robot has four legs. The outer and inner pairs of legs moves independently, allowing the robot to walk in the sagittal plane.

Fig. 5 shows the robot for self-contained biped walking. The robot has (a) a micro computer(H8/3067) as D/A and A/D converters, (b) two CO₂ bottles as the air supply sources, and (c) six electromagnetic valves for the air supply/exhaust. Although the PC currently calculates to operate the valves, the micro computer will do so in the future. The shape of the foot in fig.5(d) is an arc with a radius of 125[mm] and a length of 160[mm]. It has an ON/OFF switch on the sole, and the switch detects the collision of the foot on the ground to make locomotion as described in a next section. Table 1 shows weight and size of the links of the robot. The

4 TAKUMA *et al.*

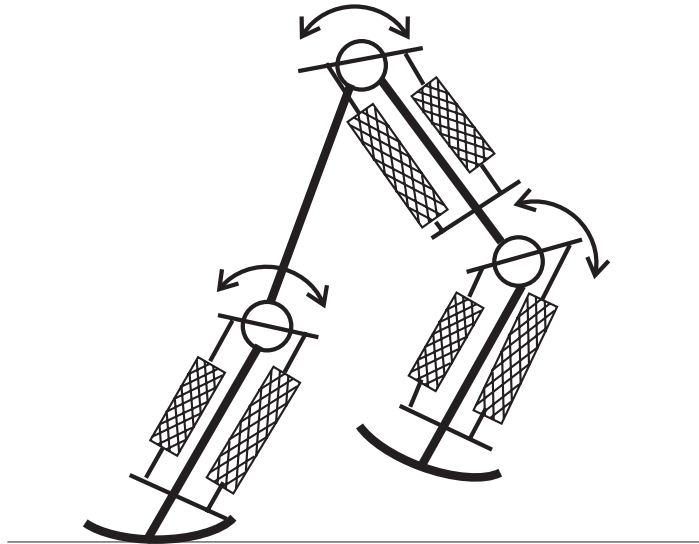

Fig. 2. A brief picture of the developed robot. It has three joints : two knees and one hip, and each joint is rotated by two muscles which are arranged by antagonistic pair like human ones.

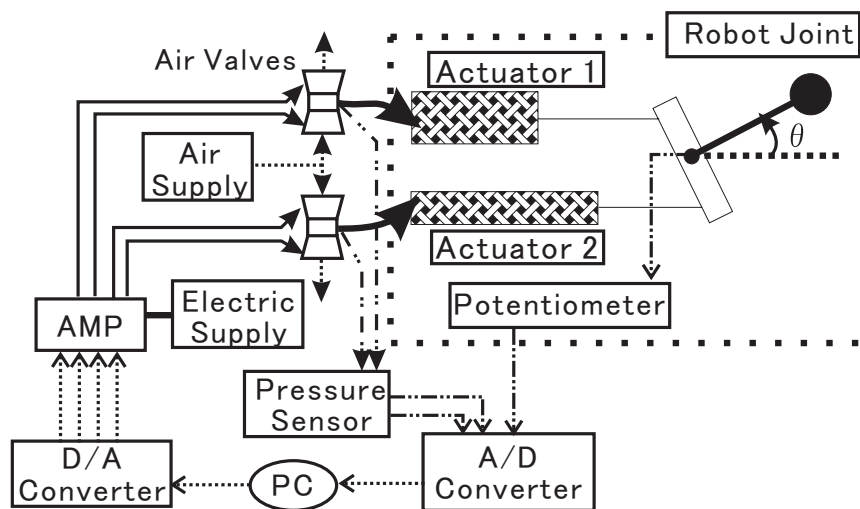

Fig. 3. Whole overview of the system

height, width, and weight of the robot is 750[mm], 350[mm], and 5[kg] respectively.

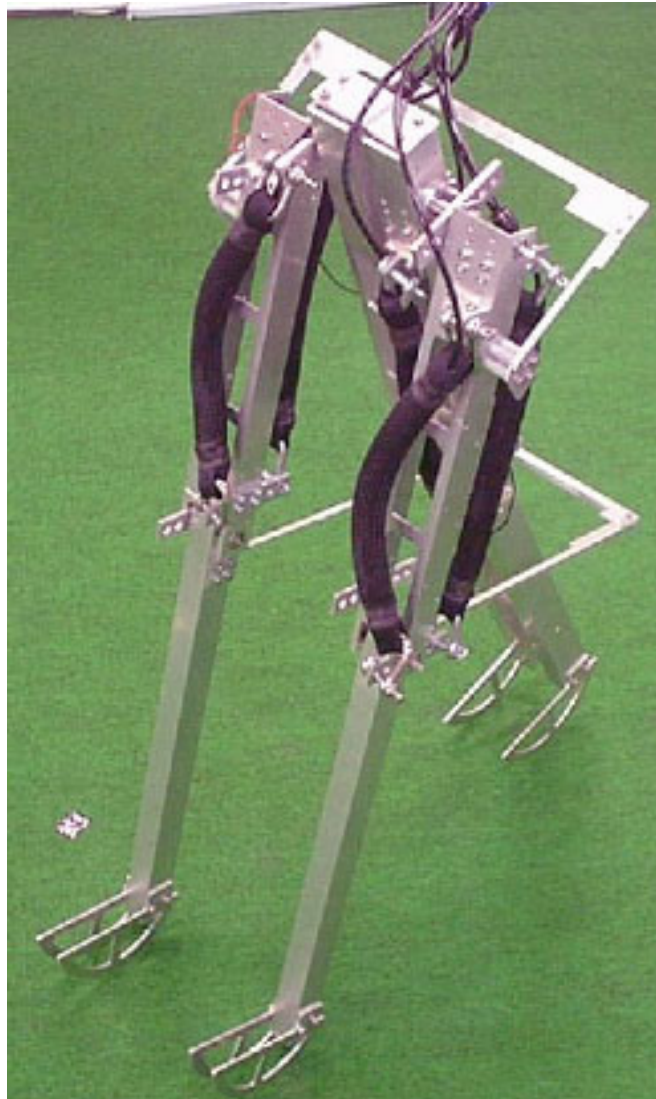

Fig. 4. A basic structure of the robot with pneumatic actuators

3. Feedback control for quasi-passive dynamic walker with pneumatic actuator

3.1. *Walking strategy*

It is difficult for the robot we developed to follow the planned trajectory because the actuator has nonlinearity. One effective approach is, as Wisse et al. did, generate the walking by operating the air valves. We operate the valves to generate a walking pattern shown in fig. 6 as mentioned below :

6 TAKUMA *et al.*

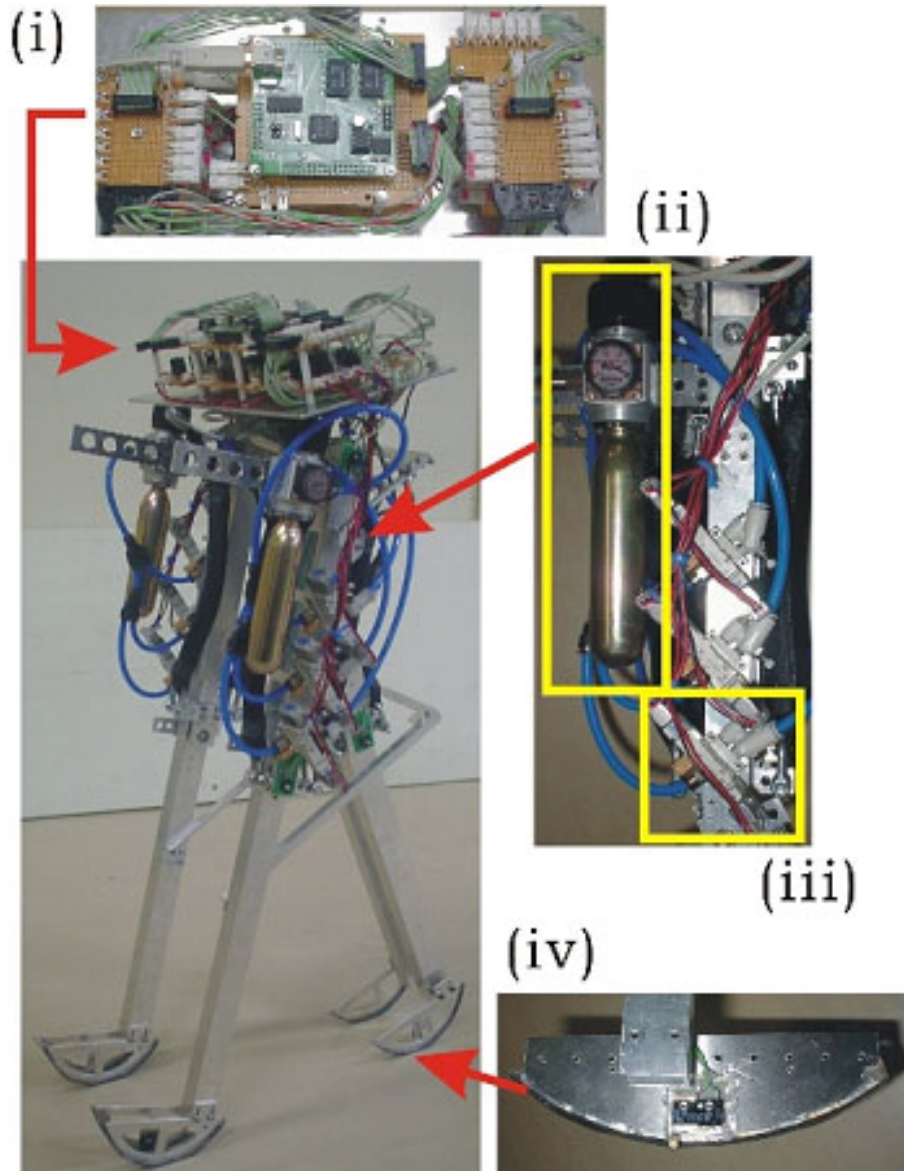

Fig. 5. The self-contained biped walker. It has (a) a micro computer H8, (b) two CO₂ bottles as air supply, (c) on/off valves, and (d) a switch attached on the foot sole

- (i) at k -th step, all valves are not operated for T_0 so that the robot keeps a posture,
- (ii) after T_0 , the valves are operated to rotate the hip joint for $S(k)$, and the knee is bent and extended within $S(k)$, and
- (iii) all valves are not operated so that the robot keeps the posture until the foot

Table 1. size and weight of the 2D biped robot

Link	length[m]	weight[kg]
Outer thigh	0.3	2.18
Outer shank	0.35	0.46
Inner thigh	0.3	2.12
Inner shank	0.35	0.5

of the swing leg touches the ground. After the heel strike, the swinging leg changes to be the support one, and return to the operation (i).

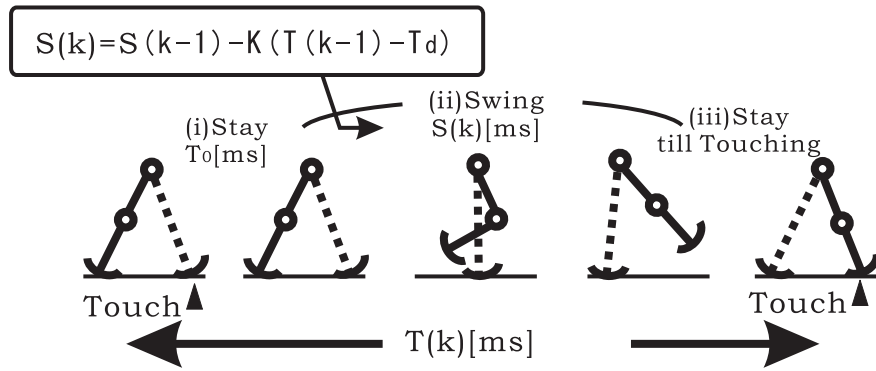

Fig. 6. Walking pattern and basic idea of a controller

In the operation (i) and (iii), the collision of the ground is detected by the switch on the sole shown in fig. 5(d). Operations (i)-(iii) correspond to items (i)-(iii) in fig. 6, respectively. Let $T(k)$ be a walking cycle from the heel strike to the other heel strike at k -th step. In the walking pattern, there are two walking parameters, T_0 and $S(k)$, which can be operated directly.

3.2. Designing controller to stabilize walking cycle

Wisse et al. fixed T_0 and $S(k)$ and they realized walking. However the robot can not adapt against perturbations such as a variation of floor surface or a difference in floor level. In this paper, we consider an approach to design a controller for stabilizing walking cycle.

In order to design a controller for stabilizing walking cycle, there are some approaches. One of the approaches is that robot model is derived numerically and the controller is designed from the model analytically. However, as mentioned in previous section, it is difficult to obtain the model of the robot with pneumatic actuators because the actuator has complex nonlinearity.

We take another approach. In our approach, a real robot is built and a causal relation between walking parameters and a walking cycle is observed by using the real robot. Though it is impossible to derive the robot's model, we can observe the causal relation by changing walking parameters, and a feed-back controller can be designed from the relation.

After some trials of walking, we fixed T_0 as $T_0 = 16[\text{ms}]$ empirically, and we found that there is some relation between the valve opening duration $S(k)$ and walking cycle $T(k)$. Then we observed the relation between them to design the feed-back controller.

Fig. 7 shows the causal relation between $S(k)$ and $T(k)$ when the inner leg swings. The walking duration $S(k)$ is changed randomly from 200[ms] to 450[ms]. When the duration is short, the walking cycle becomes short and vice versa. As a result we can find the positive correlation between $S(k)$ and $T(k)$. Similar correlation can be observed when outer leg swings as shown in fig. 8. The correlation rate is 0.72 when the duration to swing inner leg is changed and 0.75 in the case of outer leg.

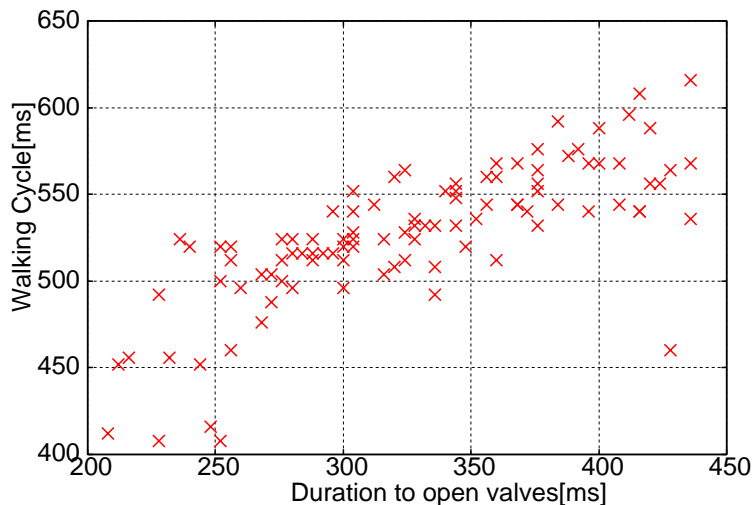

Fig. 7. Positive correlation between duration of opening valves $S(k)$ and walking cycle $T(k)$ when the inner leg swings

From the positive correlation between $S(k)$ and $T(k)$, we propose a control law to stabilize walking cycle $T(k)$ such as

$$S(k) = S(k-1) - K(T(k-1) - T_d), \quad (1)$$

where K is a positive constant, and T_d is a desired walking cycle. When the walking cycle is longer than desired walking cycle, $S(k)$ becomes shorter to let the walking cycle become shorter in the next step, and vice versa.

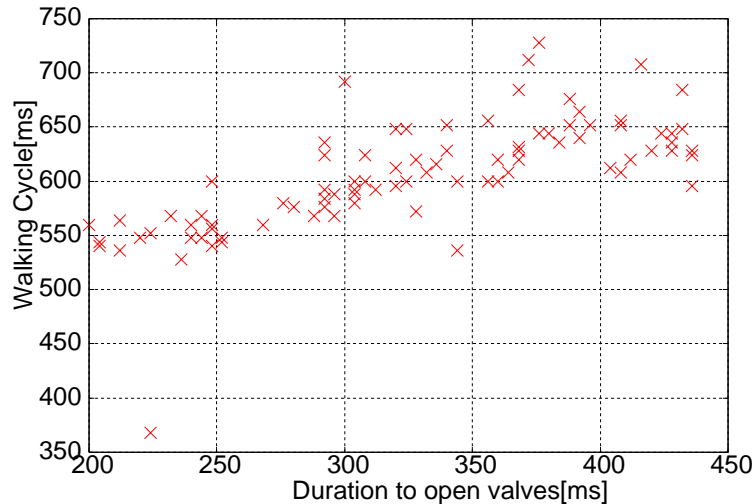

Fig. 8. Positive correlation between duration of opening valves $S(k)$ and walking cycle $T(k)$ when the outer leg swings

The outer and inner legs of the real walker we developed have different dynamics because the outer leg has CO₂ bottles and the inner leg has a micro computer whose weight and position are different. Therefore the walking cycles of each leg are not the same. In this paper, revised from eqn. (1), the control laws are proposed : supposing that the inner leg swings for $S_{in}(k)$ at k -th step, and the outer leg swings for $S_{out}(k)$, they are determined as

$$\begin{aligned} S_{in}(k) &= S_{in}(k-1) - K_{in}(T_{in}(k-1) - T_{din}), \\ S_{out}(k) &= S_{out}(k-1) - K_{out}(T_{out}(k-1) - T_{dout}), \end{aligned} \quad (2)$$

where K_{in} and K_{out} are positive constants, $T_{in}(k)$ and $T_{out}(k)$ are, as shown in fig. 9, walking cycles at k -th step when inner and outer leg swings, respectively, and T_{dout} and T_{din} are the desired walking cycles when outer and inner leg swings, respectively. From fig. 7 and fig. 8, a gradient of positive correlation is about 0.5 in each graph and an average walking cycles when inner and outer leg swings are 526[ms] and 605[ms], respectively. Therefore, referring the gradient and the average cycles, K_{in} and K_{out} are set as $K_{in} = K_{out} = 0.3$ and T_{din} and T_{dout} are set as $T_{din} = 560$ and $T_{dout} = 640$, respectively.

4. Experimental results

In order to evaluate the proposed control, we have an experiment to let the robot walk over one small difference in level. As shown in fig. 10, the robot begins to walk at (A), walks over the difference of 4[mm] at (B), and the robot successfully completes the task when it walks over the line (C).

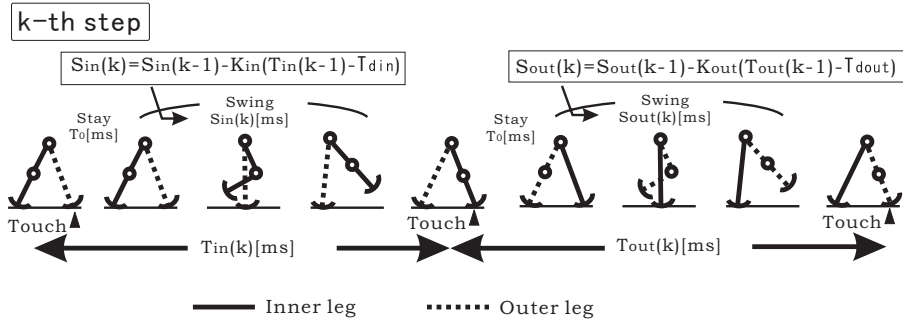

Fig. 9. Revised walking pattern and the controllers

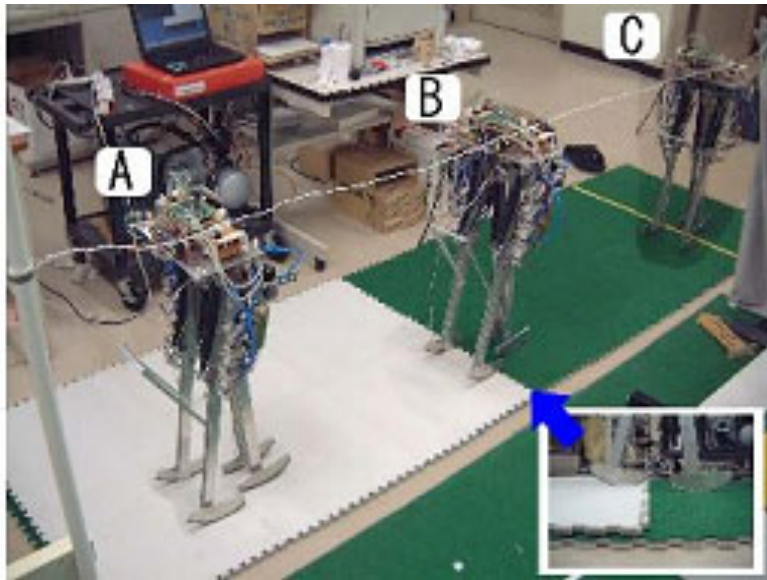

Fig. 10. Descending task : the robot starts to walk at (A), descends small difference in level of 4[mm] at (B), and task is successfully completed when the robot reaches a point (C).

Fig. 11 shows a variation of the walking cycle (a)without / (b)with proposed controller when the inner leg swings. After the robot walks down at 5th step, the walking cycle becomes shorter. When the robot walks without control, $S_{in}(k)$ and $S_{out}(k)$ are fixed, the walking cycle can not be longer and robot is fallen down at 7th step. On the other hand, when the robot walks with control, the walking cycle can be longer after descending and becomes homogeneous one when the robot walks on the flat plane.

The robot without proposed controller walks over the difference only 10 times per 100 trials, and the robot with the controller walks down 82 times per 100 trials.

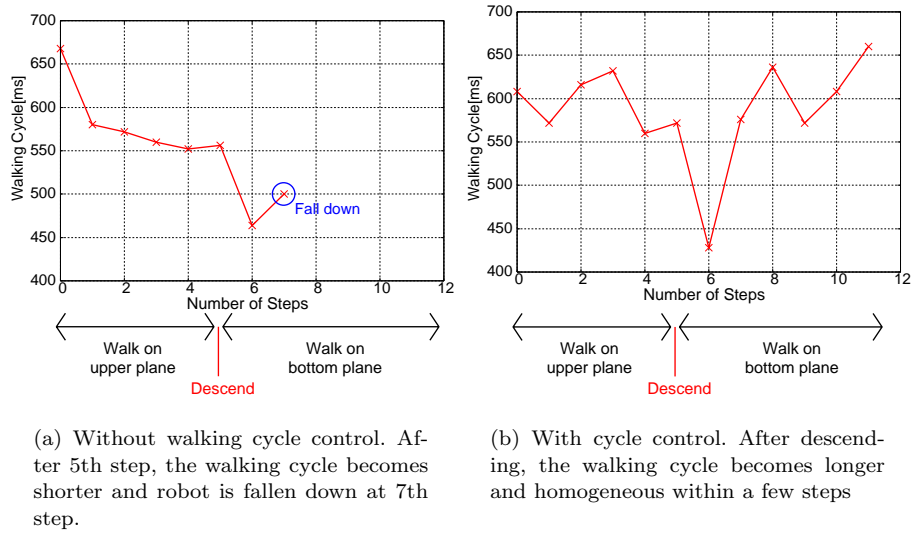

Fig. 11. The result of walking cycle when the inner leg is swung without / with the control.

Though the robot without control sometimes walks over the difference, the walking cycle is not as long as before descending. We then have an another experiment to walk over two differences in level shown in fig. 12. As a result, the robot with controller can walk over two differences as shown in the fig. 12, and the one without controller can not walk over because the cycle gets shorter so that swing leg hits on the ground before it swings fully. The results of descending differences show that proposed control is effective to stabilize walking cycle against the disturbance of the walking cycle.

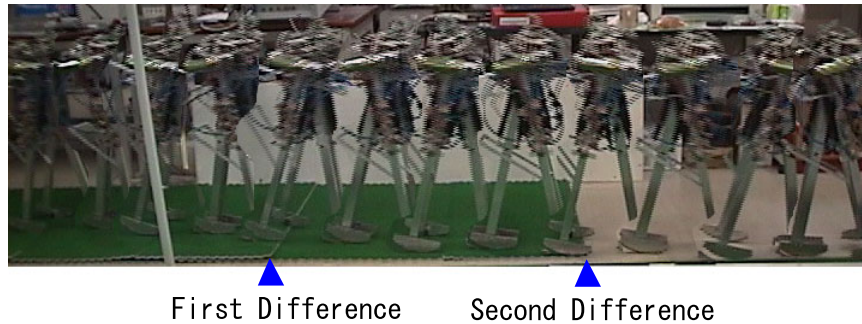

Fig. 12. The result of walking with proposed controller when the robot walks over two differences in level

5. Conclusion

This paper introduces the developed biped walker that has McKibben artificial muscles. The height, width, and weight of the robot are about 750[mm], 350[mm], and 5[kg] respectively. It has three degrees of freedom, and it is designed to be self-contained.

We then describe an approach to design a controller to stabilize walking cycle. Although the McKibben muscle is suitable for the quasi-passive dynamic walking, it has too complex nonlinearity to be derived numerically. Therefore it is difficult to design the controller analytically. We then observe the causal relation between walking parameters and walking cycle by using real robot. After some trials to walk on the real robot, we found the positive correlation between the valve opening duration and walking cycle. We then designed the feed-back controller from the relation.

In the experiments, we let the robot walk over one difference in level with and without control. When the robot walks without control, the walking cycle is kept shorter after descending the difference, but the cycle with the control resumes to be as long as before descending the difference. The robot with control can walk over two differences, but the robot without control can not walk over because the cycle becomes so fast after descending second difference that the leg can not fully swing.

Our ultimate goals are that robots with pneumatic actuators can walk against larger perturbation and can do more dynamic motions such as running and jumping. In order to realize such motions, we are now planning to build up the mechanism of the robot in order to be able to change its dynamics easily, such as adding upper body or ankle joints. This is a future issue.

References

1. M. Wisse and J. van Frankenhuyzen, *Design and Construction of MIKE; 2D autonomous biped based on passive dynamic walking*, 2nd International Symposium on Adaptive Motion of Animals and Machines, WeP-I-1, October, 2002
2. Y.Sugimoto, K.Osuka, *Walking Control of Quasi-Passive-Dynamics-Walking Robot "Quartet III" based on Delayed Feedback Control*, Proceedings of 5th International Conference on Climbing and Walking Robots (CLAWAR 2002), Paris, France, 2002, September.
3. Fumihiko Asano, Masaki Yamakita, and Katsuhisa Furuta *Virtual Passive Dynamic Walking and Energy-based Control Laws*, Proceedings of the 2000 IEEE/RSJ International Conference on Intelligent Robots and Systems, pp.1149-1154, 2000
4. Fumihiko Asano, Masaki Yamakita, Norihiko Kawamichi, and Zhi-Wei LUO, *A Novel Gait Generation for Biped Walking Robots Based on Mechanical Energy Constraint*, Proceedings of the 2002 IEEE/RSJ Intl. Conference on Intelligent Robots and Systems EPFL, Lausanne, Switzerland, 2002, October
5. Richard Q. van der Linde, *Design, Analysis, and Control of a Low Power Joint for Walking Robots, by Phasic Activation of McKibben Muscles*, IEEE Transactions on Robotics and Automation, Vol.15, No.4, August 1999
6. Glenn K. Klute, Blake Hannaford, *Accounting for Elastic Energy Storage in McKibben*

- Artificial Muscle Actuators*, ASME Journal of Dynamic Systems, Measurement, and Control, vol.122, No.2, pp.386-288, 2000
7. N. Tsagarakis and Darwin G. Caldwell, *Improved Modelling and Assessment of pneumatic Muscle Actuators*, Proceedings of the 2000 IEEE International Conference on Robotics & Automation, pp.3641-3646, April 2000
 8. Darwin G. Caldwell, Gustavo A. Medrano-Cerda, and Mike Goodwin, *Control of pneumatic muscle actuators*, IEEE Control Systems, pp.40-47, February 1995
 9. Joachim Schröder, Kazuhiko Kawamura, Tilo Gockel, and Rüdiger Dillmann, *Improved control of humanoid arm driven by pneumatic actuators*, International Conference on Humanoid Robots 2003, CD-ROM, 2003
 10. HITACHI Medical corp. web page :
<http://www.hitachi-medical.co.jp/english/index.htm>